

# PRICE LIST



**APEX**<sup>®</sup>

SINCE 1959

An ISO 9001-2015 Company

## WORK HOLDING EQUIPMENTS



**PRICE LIST NO. 717 (Revised)  
w.e.f. 15th MARCH 2022**

Subject to change without prior notice



Size in mm	Price Each Rs.	Std. Pkg.
------------	----------------	-----------

**APEX CODE 701**  
Tilting & Swiveling Vice

100	12978/-	1
150	22713/-	1
200	41301/-	1

**SG 701**  
S.G. Iron Body

100	15117/-	1
150	25371/-	1
200	45783/-	1

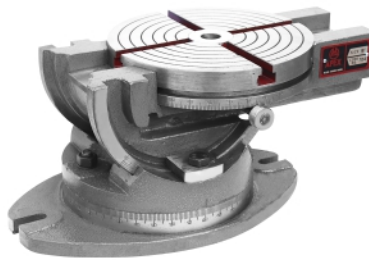

Size in mm	Price Each Rs.	Std. Pkg.
------------	----------------	-----------

**APEX CODE 704**  
Compound Angle Table (Round Table)

225	25440/-	1
-----	---------	---

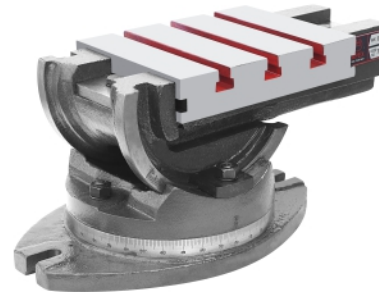

**APEX CODE 704 R**  
Compound Angle Table (Rectangular Table)

225x175	26118/-	1
---------	---------	---



**APEX CODE SG 701 A**  
Universal Machine Vice (S.G. Iron Body)

100	19506/-	2
150	27546/-	1



**APEX CODE 702**  
Shaper Vice Swivel Model (With Serrated Jaws)

150	14814/-	1
200	31029/-	1
250	46368/-	1
300	63708/-	1

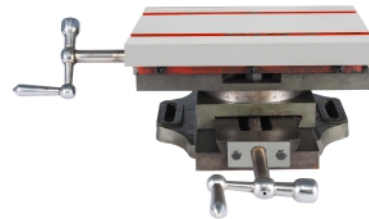

**APEX CODE 705 D**  
Compound Sliding Table (With Swivel Graduated Base)

300x200	18843/-	1
---------	---------	---



**APEX CODE 702 P**  
Shaper Vice Plain Model (With Serrated Jaws)

150	11484/-	1
200	22827/-	1
250	33960/-	1
300	45723/-	1



**APEX CODE 706**  
Compound Sliding Table (With Swivel Graduated Base)

150x150	8625/-	2
200x200	9693/-	1

Now in Dovetailed Slide



**APEX CODE 703**  
Milling Machine Vice (Swivel Model)

75	7623/-	2
100	12126/-	2
150	20988/-	1
200	39684/-	1
250	67032/-	1
300	91164/-	1

**SG 703**  
S.G. Iron Body

75	8361/-	2
100	14682/-	2
150	24066/-	1
200	45531/-	1

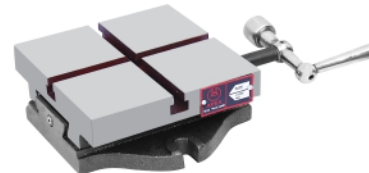

**APEX CODE 706 S**  
Single Sliding Table (With 3/8" cross slots)

150x150	4878/-	3
200x200	5328/-	3

Now in Dovetailed Slide



**APEX CODE 703 P**  
Milling Machine Vice (Plain Model)

75	5916/-	2
100	10191/-	2
150	15870/-	1
200	30567/-	1
250	51480/-	1
300	72396/-	1

**SG 703 P**  
S.G. Iron Body (Plain Model)

75	7302/-	2
100	12333/-	2
150	18051/-	1
200	34683/-	1

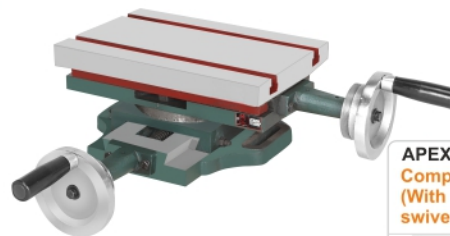

**APEX CODE 707**  
Compound Sliding Table (With calibrated wheels & swivel graduated base)

300x200	21495/-	1
---------	---------	---

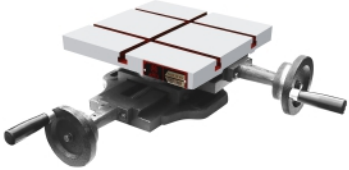

Size in mm	Price Each Rs.	Std. Pkg.
300 x 300	24048/-	1
300 x 500	50523/-	1
400 x 400	58476/-	1

**APEX CODE 707A**  
Compound Sliding Table (with calibrated wheels & swivel graduated base)



Size in mm	Price Each Rs.	Std. Pkg.
300 x 300	24048/-	1
300 x 500	50523/-	1
400 x 400	58476/-	1

**APEX CODE 707T**  
Compound Sliding Table (with calibrated wheels & swivel graduated base)



Size in mm	Price Each Rs.	Std. Pkg.
150 x 150	9543/-	2
200 x 200	10512/-	1
250 x 250	17805/-	1

**APEX CODE 708**  
Compound Sliding Table (with calibrated wheels & swivel graduated base)

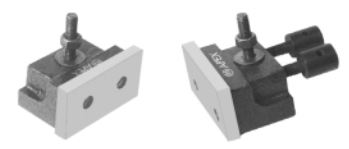

Size in mm	Price Each Rs.	Std. Pkg.
150 x 150	1311/-	4
200 x 200	1191/-	4
300 x 200	1311/-	4
300 x 300	1311/-	4
400 x 400	3582/-	4
300 x 500	3582/-	4

**APEX CODE 708J**  
Jaws for Compound Sliding Tables (PAIR)



Size in mm	Price Each Rs.	Std. Pkg.
150 x 150	6006/-	3
200 x 200	6687/-	3

**APEX CODE 708S**  
Single Sliding Table (With calibrated wheels)



Size in mm	Price Each Rs.	Std. Pkg.
100	12222/-	1
125	19515/-	1
150	25620/-	1
200	52404/-	1

**APEX CODE 709**  
Standard Machine Vice



Size in mm	Price Each Rs.	Std. Pkg.
80	1626/-	6
100	2712/-	4
125	3825/-	3
150	5424/-	2

**APEX CODE 710**  
Unigrip Machine Vice (Cast Iron Frame)

Size in mm	Price Each Rs.	Std. Pkg.
80	1890/-	6
100	3000/-	4
125	4245/-	3
150	5997/-	2

**SG 710**  
S.G. Iron Body



Size in mm	Price Each Rs.	Std. Pkg.
175 x 250	15711/-	1

**APEX CODE 711**  
Vertical Sliding Table (With calibrated wheels & Swivel calibrated base)

S.G. Iron



Size in mm	Price Each Rs.	Std. Pkg.
100	5292/-	3
150	12108/-	2
200	23844/-	1

**APEX CODE 712**  
Drill Vice (Deluxe Model)



Size in mm	Price Each Rs.	Std. Pkg.
75	2181/-	6
100	3162/-	4
125	4506/-	4
150	6801/-	4
200	11487/-	2

**APEX CODE 713**  
Drill Machine Vice

**SG 713**  
S.G. Iron Body

Size in mm	Price Each Rs.	Std. Pkg.
75	2355/-	6
100	3474/-	4
125	4977/-	4
150	7722/-	4
200	12870/-	2
250	22530/-	1
300	27684/-	1



Size in mm	Price Each Rs.	Std. Pkg.
75	2094/-	6
100	2767/-	4
125	3736/-	4
150	4545/-	4
200	8532/-	2

**APEX CODE 713 E**  
Drill Machine Vice (Economy Model) Unbreakable S.G. Iron Body



Size in mm	Price Each Rs.	Std. Pkg.
75	1671/-	6
100	3327/-	4
115	3828/-	2
125	5004/-	2
150	6000/-	2
200	9069/-	1
250	15171/-	1
300	18783/-	1
400	25875/-	1

**APEX CODE SG 714**  
Machinist Bench Vice (Fixed Base) Unbreakable S.G. Iron Body



Size in mm	Price Each Rs.	Std. Pkg.
75	2205/-	6
100	4035/-	4
125	6228/-	2
150	7320/-	2
200	11376/-	1
250	16230/-	1
300	19758/-	1

**APEX CODE SG 714S**  
Machinist Bench Vice (Swivel Base) Unbreakable S.G. Iron Body



Size in mm	Price Each Rs.	Std. Pkg.
150	10851/-	2
200	13815/-	1
250	18876/-	1
300	28911/-	1
375	49827/-	1
450	84816/-	1
500	93000/-	1

**APEX CODE 715**  
Rotary milling Table (Plain Model)



Size in mm	Price Each Rs.	Std. Pkg.
<b>APEX CODE 715E</b> <b>Universal Rotary milling Table (Horizontal &amp; Vertical)</b>		
100	7119/-	2
150	11406/-	2
200	16371/-	1
250	22275/-	1
300	34797/-	1
375	52002/-	1
450	91389/-	1
500	99060/-	1



Size in mm	Price Each Rs.	Std. Pkg.
<b>APEX CODE 718</b> <b>Table vice</b>		
25	240/-	20
40	246/-	20
50	270/-	20
60	324/-	10
75	387/-	10
100	477/-	06



Size	Price Each Rs.	Std. Pkg.
<b>APEX CODE 715H</b> <b>Indexing Device (For Code 715 &amp; 715E)</b>		
Small H-1		
150	5085/-	4
200	5085/-	4
250	5085/-	4
Large H-2		
300	7215/-	4
375	7215/-	4
450	7215/-	4
500	7215/-	4



Size	Price Each Rs.	Std. Pkg.
<b>APEX CODE 719</b> <b>Preci Self Centering Vice (Swivel Base)</b> <b>Unbreakable S.G. Iron Body</b>		
100	9255/-	1
150	17688/-	1



Size	Price Each Rs.	Std. Pkg.
<b>APEX CODE 716</b> <b>Table Vice (Fixed base)</b>		
30	318/-	12
40	387/-	12
50	402/-	12
60	564/-	8
75	816/-	8



Size	Price Each Rs.	Std. Pkg.
<b>APEX CODE 719P</b> <b>Preci Self Centering Vice (Plain Model)</b> <b>Unbreakable S.G. Iron Body</b>		
100	7650/-	1
150	13407/-	1

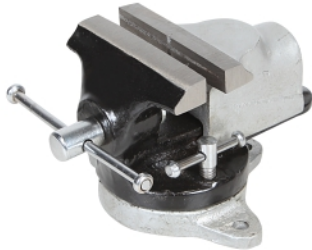

Size	Price Each Rs.	Std. Pkg.
<b>APEX CODE 716S</b> <b>Table Vice Swivel Base</b>		
30	414/-	12
40	450/-	12
50	525/-	12
60	798/-	8
75	1101/-	8



Size	Price Each Rs.	Std. Pkg.
<b>APEX CODE SG 720</b> <b>Precision Machine Vice (Swivel Base)</b> <b>S.G. Iron Body</b>		
100	8775/-	2
150	16200/-	1

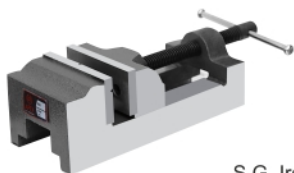

Size	Price Each Rs.	Std. Pkg.
<b>APEX CODE 717</b> <b>Empire Machine Vice</b>		
40	621/-	8
60	1782/-	6
75	3012/-	6
100	4848/-	4

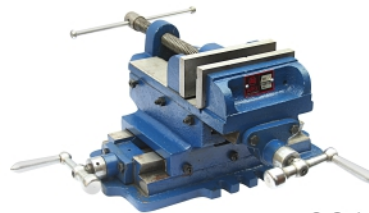

Size	Price Each Rs.	Std. Pkg.
<b>APEX CODE 721</b> <b>Universal Compound Vice</b> <b>Unbreakable S.G. Iron Body</b>		
100	10476/-	1
125	13260/-	1

S.G. Iron

S.G. Iron



Size	Price Each Rs.	Std. Pkg.
<b>APEX CODE 717A</b> <b>Empire Angle Machine Vice</b>		
60	3024/-	6
75	4560/-	4

S.G. Iron

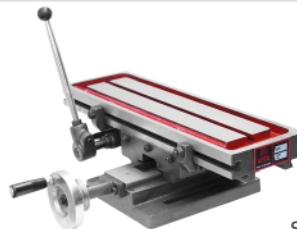

Size	Price Each Rs.	Std. Pkg.
<b>APEX CODE 722</b> <b>Profiling Milling &amp; Slotting Slide</b>		
450 x 125	22338/-	1

S.G. Iron

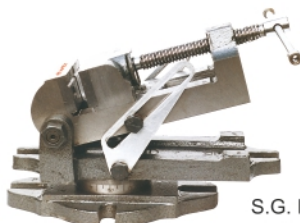

Size	Price Each Rs.	Std. Pkg.
<b>APEX CODE 717 AS</b> <b>Empire Angle Machine Vice (With graduated Swivel Base)</b>		
60	3831/-	4
75	5523/-	4

S.G. Iron

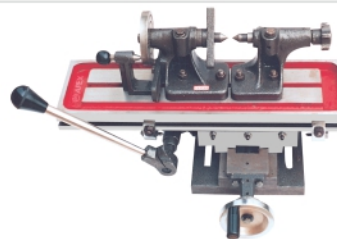

Size	Price Each Rs.	Std. Pkg.
<b>APEX CODE 722D</b> <b>Profiling Milling &amp; Slotting Slide with Indexing Dividing Head and Tail Stock</b>		
450 x 125	27060/-	1

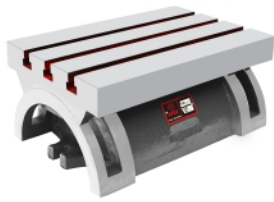

Size in mm	Price Each Rs.	Std. Pkg.
------------	----------------	-----------

**APEX CODE 723**  
**Tilting Table (Graduated)**

125 x 175	10269/-	2
175 x 250	16392/-	1
250 x 375	34026/-	1



Size in mm	Price Each Rs.	Std. Pkg.
------------	----------------	-----------

**APEX CODE 723S**  
**Tilting Table (With Swivel Base)**

125 x 175	16050/-	2
175 x 250	23124/-	1
250 x 375	54336/-	1



**APEX CODE 724**  
**Self Centering Shaft Vice**

10 to 80	22518/-	1
50 to 150	50403/-	1



**APEX CODE SG 725**  
**Drill Press Vice (German Type) S.G. Iron Body**

75	1839/-	6
100	2505/-	4
125	3321/-	4
150	4149/-	2
200	6672/-	2



**APEX CODE 726**  
**Hand Vice Steel**

75	138/-	20
100	180/-	20
125	228/-	20
150	273/-	20
200	501/-	10



**APEX CODE 727**  
**Draw Vice Steel**

150	1101/-	10
200	1566/-	10
250	2424/-	6
300	2919/-	6



**APEX CODE 728**  
**Pipe Vice (Open Type) S.G. Iron Body**

3-30	1893/-	6
5-50	3000/-	4
5-75	5250/-	3
5-100	6750/-	2
50-150	16500/-	1
50-200	34500/-	1

**SG 728 S.G. Iron Body**

5-50	2745/-	4
5-75	4653/-	3
5-100	6378/-	2
50-150	13959/-	1

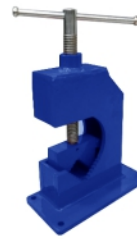

**New**

Size in mm	Price Each Rs.	Std. Pkg.
------------	----------------	-----------

**APEX CODE 728S**  
**Fabricated Steel Pipe Vice (Open Type)**

50	2904/-	4
75	4113/-	4
100	5868/-	3



**APEX CODE 729**  
**Chain Pipe Vice**

50	792/-	6
75	1131/-	6
100	1512/-	4
150	2919/-	3
200	4086/-	2



**APEX CODE 730**  
**3 Way Universal Tilt & Swivel Angle Vice**

100	18819/-	1
150	39402/-	1

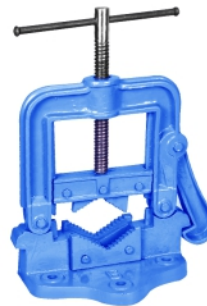

**APEX CODE 731**  
**Hinged Pipe Vice SG Iron Body**

40	1224/-	8
50	1548/-	8
60	2148/-	4
85	3255/-	3
115	4443/-	2
150	9609/-	2

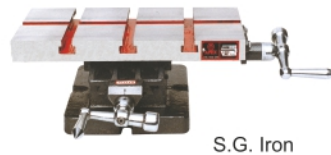

**APEX CODE 732**  
**Compound Sliding Table (With Calibrated Wheel) S.G. Iron**

300 x 150	11244/-	1
-----------	---------	---



**APEX CODE 733**  
**Table Vice with Clamp (Deluxe Model)**

30	306/-	20
40	393/-	20
50	408/-	20
60	567/-	20
75	843/-	10



**APEX CODE 733S**  
**Table Vice with Clamp (Swivel Base) (Deluxe Model)**

30	435/-	20
40	459/-	20
50	540/-	20
60	810/-	10
75	1167/-	10



Size in mm	Price Each Rs.	Std. Pkg.
------------	----------------	-----------

**APEX CODE SG 734**  
**Cross Rib Bench Vice (Fixed Base)**  
**S.G. Iron Body**

75	1710/-	8
100	2892/-	4
125	4374/-	4
150	6963/-	2
200	10776/-	1



**APEX CODE SG 734S**  
**Cross Rib Bench Vice (Swivel Base)**  
**S.G. Iron Body**

75	2427/-	6
100	3825/-	4
125	5775/-	3
150	9285/-	2
200	14586/-	1

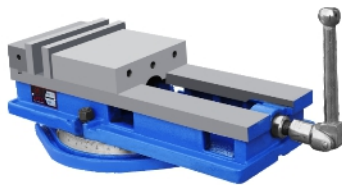

**APEX CODE 735**  
**Tilt Lock Machine Vice**  
**Swivel Model (S.G. Iron Body)**

Jaw Width in mm	Opening in mm		
100	150	17409/-	1
125	150	20370/-	1
150	175	26097/-	1
160	225	28224/-	1
200	250	47337/-	1
200	300	48648/-	1
310	400	79056/-	1

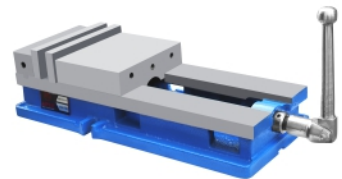

**APEX CODE 735P**  
**Tilt Lock Machine Vice**  
**Plain Model (S.G. Iron Body)**

Jaw Width in mm	Opening in mm		
100	150	14691/-	1
125	150	14931/-	1
150	175	19563/-	1
160	225	21657/-	1
200	250	37311/-	1
200	300	38508/-	1
310	400	75558/-	1

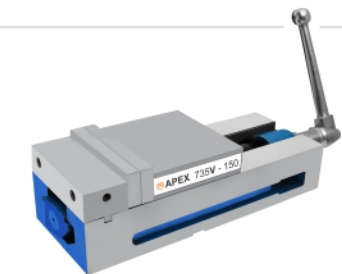

**APEX CODE 735 V**  
**Precision Tilt Lock Machine Vice**

150mm	22572/-
-------	---------

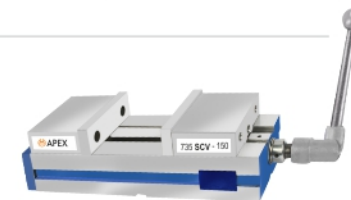

**APEX CODE 735 SCV**  
**Self Centering Tilt Lock Machine Vice**

150	23553/-
-----	---------



Size in mm	Price Each Rs.	Std. Pkg.
------------	----------------	-----------

**APEX CODE SG 736**  
**Machine Clamps (Pair)**  
**Unbreakable S.G. Iron Body**

60	4059/-	2
75	6981/-	2
100	18888/-	1



**APEX CODE 737**  
**Wood Working Vice**

150	2172/-	6
175	3369/-	4
200	4362/-	3
225	6384/-	3

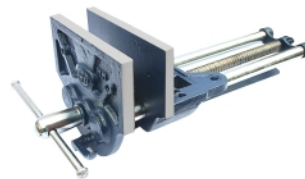

**APEX CODE 737QR**  
**Quick Release Wood Working Vice**

150	2706/-	6
175	3903/-	4
200	5043/-	3
225	7101/-	3

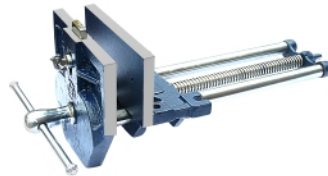

**APEX CODE 738**  
**Wood Worker's Vice**  
**(with front dog)**

175	4080/-	4
200	4782/-	3
225	7239/-	3



**APEX CODE 738QR**  
**Quick Release Wood Worker's Vice**  
**(with front dog)**

175	4413/-	4
200	5166/-	3
225	7713/-	3

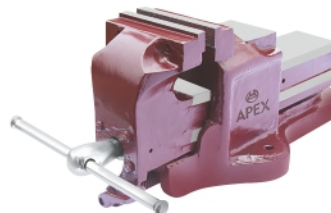

**APEX CODE 739**  
**Quick Action Bench Vice**  
**(Double Rib)**  
**Unbreakable S.G. Iron Body**

100	8010/-	3
115	8964/-	3
125	11502/-	2
150	13644/-	2



Size in mm	Price Each Rs.	Std. Pkg.
<b>APEX CODE 740</b> <b>Heavy Duty Bench Vice Deluxe (Double Rib)</b> <b>Unbreakable S.G. Iron Body</b>		
80	2601/-	4
90	3810/-	4
100	5526/-	3
115	6945/-	3
125	8097/-	2
150	10746/-	2
200	15486/-	1



Size in mm	Price Each Rs.	Std. Pkg.
<b>APEX CODE 740S</b> <b>Heavy Duty Bench Vice Deluxe (Double Rib) Swivel Base</b> <b>Unbreakable S.G. Iron Body</b>		
80	3864/-	4
90	4821/-	4
100	7242/-	3
115	8364/-	3
125	10221/-	2
150	13257/-	2
200	20544/-	1



Size in mm	Price Each Rs.	Std. Pkg.
<b>APEX CODE 741</b> <b>Mechanic's Bench Vice (Fixed Base)</b> <b>Unbreakable S.G. Iron Body</b>		
60	1224/-	6
65	1452/-	6
80	1977/-	6
90	2802/-	4
100	4926/-	4
115	5268/-	4
125	6567/-	2
150	8214/-	2
200	13152/-	1
250	24582/-	1
300	27741/-	1



Size in mm	Price Each Rs.	Std. Pkg.
<b>APEX CODE 741S</b> <b>Mechanic's Bench Vice (Swivel Base)</b> <b>Unbreakable S.G. Iron Body</b>		
65	2187/-	6
80	3087/-	6
90	4059/-	4
100	6687/-	3
115	7059/-	3
125	8997/-	2
150	11148/-	2
200	17853/-	1



Size in mm	Price Each Rs.	Std. Pkg.
<b>APEX CODE 742F</b> <b>Permanent Magnetic Chuck Fine Pole (Rectangular)</b>		
100 x 150	8448/-	2
100 x 200	9504/-	2
125 x 250	13839/-	2
150 x 250	15246/-	2
150 x 300	17853/-	1
150 x 350	19641/-	1
150 x 400	21603/-	1
150 x 450	26676/-	1
150 x 600	43791/-	1
200 x 300	21429/-	1
200 x 350	23577/-	1
200 x 400	28443/-	1
200 x 450	37596/-	1
200 x 500	45234/-	1
200 x 600	59823/-	1
250 x 600	75051/-	1
300 x 600	93141/-	1
250 x 750	121731/-	1
300 x 750	141738/-	1



Size in mm	Price Each Rs.	Std. Pkg.
<b>APEX CODE 742T</b> <b>Permanent Magnetic Chuck Through Pole (Rectangular)</b>		
100 x 150	11511/-	2
100 x 200	12555/-	2
125 x 250	17265/-	1
150 x 300	23022/-	1
150 x 350	25908/-	1
200 x 350	28116/-	1
150 x 400	28509/-	1
200 x 400	31794/-	1
150 x 450	33570/-	1
200 x 450	46773/-	1
200 x 500	54540/-	1
250 x 500	70971/-	1



Size in mm	Price Each Rs.	Std. Pkg.
<b>APEX CODE 743F</b> <b>Permanent Magnetic Chuck Fine Pole (Circular)</b>		
150	12891/-	1
200	16857/-	1
225	18990/-	1
250	21435/-	1
300	27945/-	1
350	47961/-	1
400	74016/-	1
450	88776/-	1



Size in mm	Price Each Rs.	Std. Pkg.
<b>APEX CODE 744</b> <b>Engineer's Vice</b> <b>Unbreakable S.G. Iron Body</b>		
100	5109/-	3
125	8580/-	2
150	16626/-	2



Size in mm	Price Each Rs.	Std. Pkg.
<b>APEX CODE 745</b> <b>Milling Machine Vice Deluxe (Swivel Model)</b>		
100	14904/-	2
150	25665/-	1
200	43680/-	1



Size in mm	Price Each Rs.	Std. Pkg.
<b>APEX CODE 745P</b> <b>Milling Machine Vice Deluxe (Plain Model)</b>		
100	9933/-	2
150	18564/-	1
200	32760/-	1



Size in mm	Price Each Rs.	Std. Pkg.
<b>APEX CODE 746</b>		
<b>Machinist Bench Vice (As Per IS 2586-1986)</b>		
	<b>Bronze Nut</b>	<b>FG Nut</b>
50	1575/-	1350/-
60	2265/-	1950/-
75	3438/-	2937/-
100	6543/-	5676/-
125	8736/-	7593/-
150	10893/-	9489/-



Size	Price Each Rs.	Std. Pkg.
<b>APEX CODE 747</b>		
<b>Pipe Vice (Square Pillar)</b>		
35	924/-	8
50	1221/-	6
75	2010/-	4
100	2727/-	3
150	5898/-	2



Size	Price Each Rs.	Std. Pkg.
<b>APEX CODE 747R</b>		
<b>Pipe Vice (Round Pillar)</b>		
35	1644/-	8
50	2094/-	6
75	3393/-	4
100	6252/-	2



Size	Price Each Rs.	Std. Pkg.
<b>APEX CODE 748</b>		
<b>Preci Milling Machine Vice (Swivel Model)</b>		
100	14055/-	2
150	26598/-	1
200	49698/-	1
<b>SG 748</b>		
<b>S.G. Iron Body</b>		
100	15504/-	2
150	33417/-	1
200	62340/-	1



Size	Price Each Rs.	Std. Pkg.
<b>APEX CODE 748P</b>		
<b>Preci Milling Machine Vice (Plain Model)</b>		
100	11799/-	2
150	19635/-	1
200	37542/-	1
<b>SG 748P</b>		
<b>S.G. Iron Body</b>		
100	12990/-	2
150	20976/-	1
200	39984/-	1



Size	Price Each Rs.	Std. Pkg.
<b>APEX CODE 749</b>		
<b>Preci Tilting &amp; Swivelling Vice</b>		
100	16965/-	1
150	28017/-	1
<b>SG 749</b>		
<b>S.G. Iron Body</b>		
100	18600/-	1
150	31395/-	1

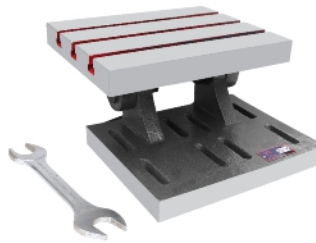

Size in mm	Price Each Rs.	Std. Pkg.
<b>APEX CODE 750</b>		
<b>Swivel Angle Table</b>		
125 x 150	5859/-	2
150 x 200	7326/-	2
200 x 250	14640/-	1
250 x 300	26697/-	1
300 x 375	44541/-	1



Size	Price Each Rs.	Std. Pkg.
<b>APEX CODE 751</b>		
<b>Plain Angle Plates Machined</b>		
50x50x50	546/-	6
75x75x75	861/-	6
100x100x100	1578/-	6
125x125x125	2631/-	4
150x150x150	4212/-	3
200x200x200	8946/-	2
250x250x250	15267/-	1
300x300x300	24720/-	1

Size	Price Each Rs.	Std. Pkg.
<b>APEX CODE 752</b>		
<b>Plain Angle Plates Precision Ground</b>		
50x50x50	672/-	6
75x75x75	1029/-	6
100x100x100	1734/-	6
125x125x125	2889/-	4
150x150x150	4620/-	3
200x200x200	9819/-	2
250x250x250	16749/-	1
300x300x300	27126/-	1



Size	Price Each Rs.	Std. Pkg.
<b>APEX CODE 753</b>		
<b>Slotted Angle Plates Machined (Webbed End)</b>		
90x75x65	1179/-	6
115x90x75	1317/-	6
150x125x115	2460/-	6
175x140x115	3615/-	4
200x150x125	4182/-	4
225x175x150	6792/-	3
250x200x150	7866/-	2
300x225x200	13719/-	1



Size	Price Each Rs.	Std. Pkg.
<b>APEX CODE 753G</b>		
<b>Slotted Angle Plates Precision Ground (Webbed End)</b>		
90x75x65	1419/-	6
115x90x75	1671/-	6
150x125x115	3006/-	6
175x140x115	4398/-	4
200x150x125	4920/-	4
225x175x150	7788/-	3
250x200x150	9285/-	2
300x225x200	15429/-	1



Size	Price Each Rs.	Std. Pkg.
<b>APEX CODE 754</b>		
<b>Slotted Angle Plates Machined (Open End)</b>		
115x90x75	1317/-	6
150x125x115	2463/-	6
175x140x115	4158/-	4
200x150x125	4182/-	4
225x175x150	6792/-	3
250x200x150	8256/-	2
300x225x200	16560/-	1

Size	Price Each Rs.	Std. Pkg.
<b>APEX CODE 754G</b>		
<b>Slotted Angle Plates Precision Ground (Open End)</b>		
115x90x75	1671/-	6
150x125x115	3006/-	6
175x140x115	4398/-	4
200x150x125	4920/-	4
225x175x150	7785/-	3
250x200x150	9285/-	2
300x225x200	17823/-	1





Size in mm	Price Each Rs.	Std. Pkg.
------------	----------------	-----------

**APEX CODE 755**  
**Giant Slotted Angle Plates Machined**

400x300x225	19251/-	1
500x400x300	37881/-	1
600x600x450	99981/-	1

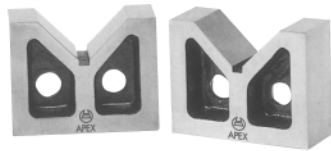

**APEX CODE 756**  
**C.I. Vee Blocks Machined (PAIR) Without Clamp**

50x32x47	939/-	6
75x60x65	1800/-	6
100x65x80	2856/-	6
125x80x100	4509/-	6
150x88x125	7914/-	3
175x113x150	11739/-	2
200x138x200	17994/-	1
250x163x250	27900/-	1
300x200x300	34200/-	1



**APEX CODE 756G**  
**C.I. Vee Blocks Precision Ground (PAIR) With One Clamp**

50x38x38	1473/-	6
75x38x38	1839/-	6
75x50x50	2112/-	6
100x38x75	2646/-	6
100x63x63	3927/-	4
100x75x75	3978/-	4
125x44x88	4647/-	4
150x50x100	5208/-	3
150x100x100	10107/-	3

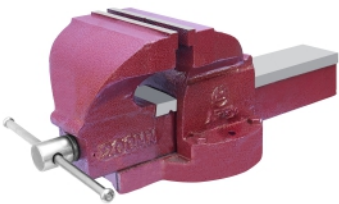

**APEX CODE 757**  
**Tool Maker's Bench Vice (Fixed Base)**

75	2484/-	6
90	3426/-	4
100	6303/-	3
125	8307/-	2
150	10947/-	2
200	16611/-	1

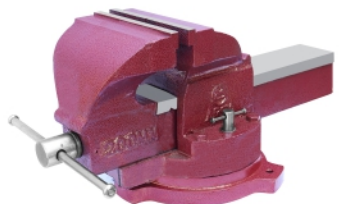

**APEX CODE 757S**  
**Tool Maker's Bench Vice (Swivel Base)**

90	4581/-	4
100	8133/-	3
125	11169/-	2
150	14364/-	2
200	21168/-	1

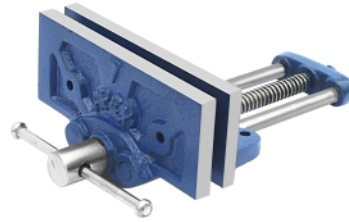

Size in mm	Price Each Rs.	Std. Pkg.
------------	----------------	-----------

**APEX CODE 758**  
**Economy Wood Worker's Vice**

150	1086/-	10
175	1443/-	8
200	2361/-	8
225	3102/-	4
250	3582/-	4
300	3945/-	3



**APEX CODE 759**  
**All Steel Bench Vice (Fixed Base)**

75	2166/-	6
100	3252/-	3
125	5007/-	2
150	6156/-	2
200	10617/-	2



**APEX CODE 759S**  
**All Steel Bench Vice (Swivel Base)**

75	2724/-	6
100	3852/-	4
125	5700/-	3
150	7794/-	2
200	12492/-	2



**APEX CODE SG 760**  
**Heavy Duty Drill Vice S.G. Iron Body**

75	2310/-	4
100	4158/-	3
150	8316/-	2



**APEX CODE 761**  
**Low Height Milling Machine Vice Fixed Base (Open Screw) Unbreakable S.G. Iron Body**

100	5508/-	2
-----	--------	---



**APEX CODE 762**  
**Super Opening Adjustable 2-Piece Milling Vice Unbreakable S.G. Iron Body**

150	10773/-	2
-----	---------	---



Size in mm	Price Each Rs.	Std. Pkg.
------------	----------------	-----------

**APEX CODE 764**  
Dial Comparator Stand  
(Supplied without dial gauge)

3	75	9204/-	1
8	60	4509/-	1
5	45	8853/-	1



**APEX CODE 765**  
Tilting Indexing Device  
(With 3 Jaws Chuck Mounting)

100	39576/-	1
200	74865/-	1



Size in mm	Price Each Rs.	Std. Pkg.
------------	----------------	-----------

**APEX CODE 769H**  
Magnetic V-Blocks Hardened (Pair)

80x65x60	14532/-	2
100x95x75	21339/-	2
150x95x75	32100/-	1
200x150x100	89601/-	1



**APEX CODE SG 770**  
Collet Fixture  
(For Traub A-25, A-42 & Herbert-2D Collets)

A-25	4893/-	2
A-42	5580/-	2
H-2D	5580/-	2

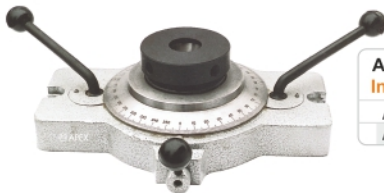

**APEX CODE 766**  
Indexing Collet Fixture

A-25	17160/-	1
A-42	17355/-	1

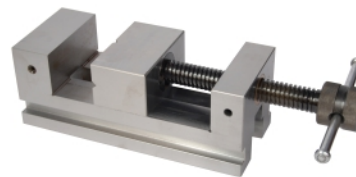

**APEX CODE 771**  
All Steel Precision Grinding Vice  
(Carbon Steel Body)

75	14046/-	2
100	20493/-	2
150	49221/-	1



**APEX CODE 767**  
Indexing Milling Fixture

100	31266/-	1
150	31404/-	1

**APEX CODE 771T**  
All Steel Precision Grinding Vice  
(Tool Steel Body)

75	19158/-	2
100	27564/-	2
150	62172/-	1



**APEX CODE 772**  
Tools Maker's Precision Screw Less Vice  
(Carbon Steel Body)

75	8400/-	2
100	15684/-	2
150	40104/-	1

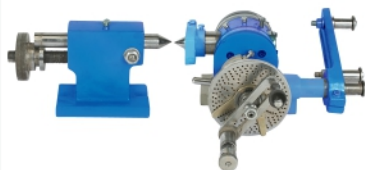

**APEX CODE 768**  
Universal Dividing Head  
Centre Height

115	30006/-	1
127	42438/-	1
140	45009/-	1
165	55566/-	1
190	63900/-	1

**APEX CODE 772T**  
Tools Maker's Precision Screw Less Vice  
(Iron Steel Body)

75	16560/-	2
100	26148/-	2
150	55956/-	1



**APEX CODE 769**  
Magnetic V-Blocks Soft (Pair)

65x60x50	8031/-	2
80x65x60	9783/-	2
100x95x75	13473/-	2
150x95x75	20964/-	1
200x150x100	62775/-	1

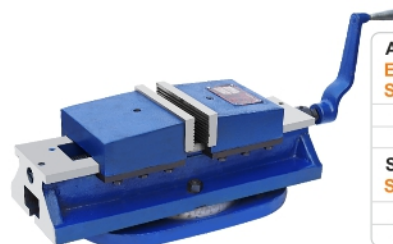

**APEX CODE 773**  
Extra Grips Machine Vice  
Swivel Model

100	13332/-	1
150	25218/-	1

**SG 773**  
S.G. Iron Body

100	14712/-	1
150	26676/-	1



Size in mm	Price Each Rs.	Std. Pkg.
100	11652/-	1
150	21537/-	1

**SG 773P**  
**S.G. Iron Body**

100	12366/-	1
150	23646/-	1



**APEX CODE 774**  
**Hi Grip Machine Vice Swivel Model**

100	16881/-	1
150	29403/-	1

**SG 774**  
**S.G. Iron Body**

100	18480/-	1
150	30375/-	1



**APEX CODE 774P**  
**Hi Grip Machine Vice Plain Model**

100	12999/-	1
150	22869/-	1

**SG 774P**  
**S.G. Iron Body**

100	13644/-	1
150	24948/-	1



**APEX CODE 775**  
**Precision Drill Press Vice**

100	4731/-	2
150	9822/-	1

**SG 775**  
**S.G. Iron Body**

100	6240/-	2
150	11568/-	1



**APEX CODE 777**  
**Stepped Angle Plates**

75x75x75	8220/-	4
100x100x100	14772/-	4



**APEX CODE 778**  
**4 Way Vee Block Cast Iron (PAIR)**

35x95x70	3711/-	
30x100x100	4227/-	
35x120x120	6468/-	
60x120x120	10080/-	
75x150x150	13335/-	
100x200x200	29067/-	



**APEX CODE 779**  
**Tool Maker's Vee Block & Clamping Sets-Precision (PAIR)**

40	3207/-	3
45	4005/-	3
50	4059/-	3
60	5565/-	3
70	5790/-	3
75	7809/-	3
80	13662/-	2
100	14496/-	2



**APEX CODE 780**  
**Ultimate Vee Block & Clamping Set**

90	5970/-	4
----	--------	---



**APEX CODE 781**  
**Micrometer Stand**

	2943/-	10
--	--------	----

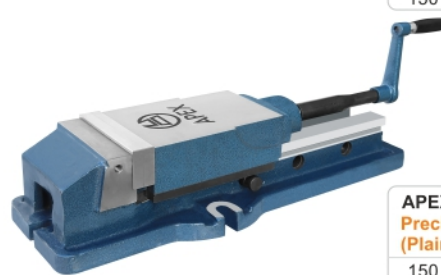

**APEX CODE 782**  
**Precision Hydraulic Machine Vice (Swivel Base)**

150 x 200	42179/-	1
150 x 300	44799/-	1

**APEX CODE 782P**  
**Precision Hydraulic Machine Vice (Plain Base)**

150 x 200	38427/-	1
150 x 300	41049/-	1



Size in mm	Price Each Rs.	Std. Pkg.
------------	----------------	-----------

**APEX CODE 783**  
Indexing Milling Fixture - Horizontal & Vertical

80/100/125 mm with Chuck & with Tail Stock	46914/-	
80/100/125 mm with Chuck & without Tail Stock	35847/-	
160mm with Chuck & with Tail Stock	62220/-	
160mm with Chuck & without Tail Stock	46866/-	
200 mm with Chuck & with Tail Stock	67890/-	
200 mm with Chuck & without Tail Stock	52335/-	



**APEX CODE SG 787**  
Multipurpose Vice  
S.G. Iron Body

125	6822/-	1
-----	--------	---



**APEX CODE 788**  
Heavy Duty Precision Machine Swivel Model  
(S.G. Ductile Iron)

150	31056/-	1
-----	---------	---



**APEX CODE 788P**  
Heavy Duty Precision Machine Plain Model  
(S.G. Ductile Iron)

150	26331/-	1
-----	---------	---



**APEX CODE 789**  
Clamp Vice (For Hand Pump)  
M.S. Steel Body

50	4131/-	4
75	4665/-	4



**APEX CODE 790**  
Precision Self Centering High Grip Shaft Vice

150	61572/-	1
-----	---------	---

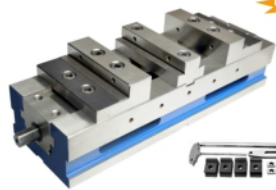

**APEX CODE 791**  
Precision Self Centering High Grip Machine Vice

150	59940/-	1
-----	---------	---

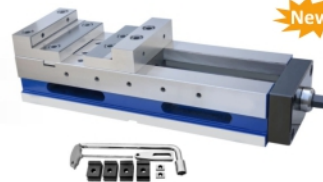

**APEX CODE 792**  
Precision High Grip Machine Vice

150	53460/-	1
-----	---------	---

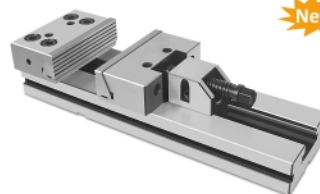

**APEX CODE 793**  
High Precision Modular Vice  
Accuracy 0.02 MM  
Hardness 57-62 HRC

100 x 165	35550/-	1
150 x 225	43029/-	1
150 x 300	48906/-	1



**APEX CODE 794**  
High Precision Modular Vice With Parallel Top Jaws  
Accuracy 0.02 MM  
Hardness 57-62 HRC

125 x 175	31932/-	1
150 x 225	37464/-	1
150 x 300	43803/-	1

**900 Series Clamps & Clamping Elements**

To Suit Price Std.  
T-Slot Each Rs. Pkg.



<b>APEX CODE 901</b> <b>Lever Clamp</b>			
12-20	2445/-	4	



<b>APEX CODE 902</b> <b>Flat Clamp</b>			
902-8	8	741/-	10
902-10	10	777/-	10
902-12	12	966/-	10
902-14	14	966/-	10
902-16	16	1299/-	10
902-18	18	1299/-	10
902-20	20	2166/-	6
902-22	22	2379/-	6



<b>APEX CODE 903</b> <b>Taper Clamp</b>			
903-8	8	753/-	10
903-10	10	795/-	10
903-12	12	1140/-	10
903-14	14	1140/-	10
903-16	16	1572/-	10
903-18	18	1572/-	10
903-20	20	2229/-	6
903-22	22	2454/-	6



<b>APEX CODE 904</b> <b>Slot Clamp</b>			
904-12	12	717/-	20
904-14	14	831/-	20
904-16	16	999/-	20
904-18	18	1140/-	10



<b>APEX CODE 905</b> <b>Stepless Height Adjustable Clamp</b> Clamp Height			
905-1212	50	1014/-	10
905-1414	50	1065/-	10
905-1616	65	1287/-	10
905A-1616	75	1683/-	10
905-1816	65	1614/-	10
905A-1816	75	2058/-	10
905-2020	85	2289/-	6
905-2220	95	2616/-	6



<b>APEX CODE 906</b> <b>Down Thrust Clamp</b>			
906-105	14 to 18	4254/-	4
906-135	14 to 18	5571/-	4
<b>APEX CODE 906E</b> <b>Separate Cylinder</b>			
906E-35		681/-	4
906E-75		1008/-	4

To Suit Price Std.  
T-Slot Each Rs. Pkg.



<b>APEX CODE 907</b> <b>Low Height Clamp</b>			
12 to 18	2331/-	4	



<b>APEX CODE 908</b> <b>Low Down Thrust Clamp</b>			
12 to 16	2079/-	4	



<b>APEX CODE 909</b> <b>Step Block Universal (PAIR)</b> Height Max			
909-1	53	489/-	10
909-2	105	783/-	10
909-3	208	1746/-	10

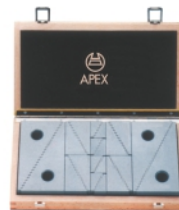

<b>APEX CODE 909S</b> <b>Step Block Set</b>			
909S-16 Pcs.		7281/-	4
909-1	909-2	909-3	
(4 Pairs)	(2Pairs)	(2Pairs)	

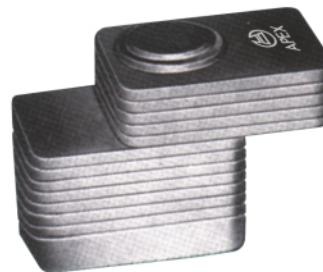

<b>APEX CODE 910</b> <b>Height Plates Adjustable</b>			
	Plate Thickness	Total Height	
910-225	2	25	294/- 20
910-250	2	50	510/- 20
910-275	2	75	756/- 20
910-2100	2	100	966/- 20
910-2125	2	125	1557/- 10
910-2150	2	150	1710/- 10
910-425	4	25	447/- 10
910-450	4	50	669/- 10
910-475	4	75	921/- 10
910-4100	4	100	1596/- 10
910-4125	4	125	1764/- 10
910-4150	4	150	2061/- 10
910-4200	4	200	2709/- 10

Size in mm	Price Each Rs.	Std. Pkg.
---------------	-------------------	--------------



**APEX CODE 911**  
Screw Jack with Steel Body  
(Having Flat Support)

Range	KN		
911-1	40-50	12	819/- 10
911-2	50-70	60	996/- 10
911-3	70-100	60	1467/- 10
911-4	100-140	100	2094/- 4
911-5	140-210	165	4212/- 2
911-6	190-300	350	6744/- 2

To Suit T-Slot	Price Each Rs.	Std. Pkg.
-------------------	-------------------	--------------



**APEX CODE 912**  
Steel Parallels  
(As per IS 4241 : 1990)  
(PAIR)

912-1	5x10x100	1224/-	3
912-2	10x20x125	1719/-	3
912-3	15x30x150	2625/-	3
912-4	20x40x200	4554/-	3
912-5	25x50x250	8427/-	2
912-6	30x60x300	14664/-	1
912-7	40x80x350	28839/-	1
912-8	50x100x400	51882/-	1



**APEX CODE DS 911**  
Screw Jack with  
double Side Flange

DS 911-1	200-320	40	3327/- 2
DS 911-2	320-550	25	4338/- 2



**APEX CODE 913**  
Self Aligning Pad  
(with Ribbed Ball)

913-1	8	8	624/- 10
913-2	10	10	783/- 10
913-3	12	12	840/- 10
913-4	16	16	1125/- 10
913-5	20	20	2808/- 5

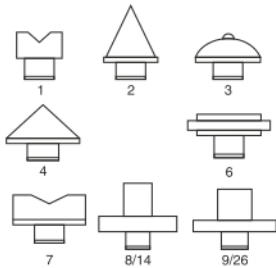

**APEX CODE P 911**  
Pads for Screw Jacks

P 911-1	186/-	10
P 911-2	186/-	10
P 911-3	252/-	10
P 911-4	258/-	10
P 911-6	285/-	10
P 911-7	372/-	10
P 911-8/14	372/-	10
P 911-9/26	567/-	10



**APEX CODE 913P**  
Self Aligning Pad  
(with Plain Ball)

913P-1	8	8	435/- 10
913P-2	10	10	630/- 10
913P-3	12	12	804/- 10
913P-4	16	16	1095/- 10
913P-5	20	20	2598/- 5



**APEX CODE SF 911**  
Screw Jack with  
Single Side Flange  
(with Ring Type Lock Nut)  
(S.G. Iron Housing  
Carbon Steel Spindle)

SF 911-1	100-140	60	2025/- 4
SF 911-2	140-200	60	2553/- 2



**APEX CODE HD 911**  
Heavy Duty Screw Jack  
(With Brass Locking Screw)

HD 911-1	200-300	80	6954/- 2
HD 911-2	280-460	60	9528/- 2
HD 911-3	430-750	50	12198/- 1
HD 911-4	320-450	80	13701/- 1
HD 911-5	410-720	60	14937/- 1



**APEX CODE 914T**  
Strap Clamp  
(As Per IS 4294:1984)  
(Adjustable Clamp with Thread  
for Adjusting Screw)  
(Only Clamp Price)  
(In Accordance with the DIN 6314)

914T-1	9x60	M8	162/- 10
914T-2	11x80	M10	297/- 10
914T-3	14x100	M12	417/- 10
914T-4	14x125	M12	504/- 10
914T-5	18x125	M16	573/- 10
914T-6	18x160	M16	654/- 10
914T-7	22x160	M20	1086/- 4
914T-8	22x200	M20	1206/- 4
914T-11	26x200	M24	1728/- 4
914T-12	26x250	M24	2079/- 4



Size in mm	Price Each Rs.	Std. Pkg.
---------------	-------------------	--------------

**APEX CODE 915**  
**Stepped Strap Clamp**

915-1	11x80	M10	333/-	10
915-2	14x100	M12	444/-	10
915-3	14x125	M12	534/-	10
915-4	18x125	M16	606/-	10
915-5	18x160	M16	696/-	10
915-6	22x160	M20	1128/-	4
915-7	22x200	M20	1248/-	4
915-8	26x200	M24	1779/-	4



**APEX CODE 916**  
**Open-End Strap Clamp**  
(As per IS 4293-1984)  
(In accordance with the  
DIN 6315-B Standard)

916-1	11x100	M10	354/-	10
916-2	14x125	M12	456/-	10
916-3	14x160	M12	543/-	10
916-4	14x200	M12	654/-	10
916-5	18x160	M16	780/-	10
916-6	18x200	M16	924/-	10
916-7	18x250	M16	1206/-	10
916-8	22x200	M20	1821/-	4
916-9	22x250	M20	2166/-	4
916-10	22x315	M20	2793/-	4
916-11	26x200	M24	1860/-	4
916-12	26x250	M24	2223/-	4
916-13	26x315	M24	2814/-	4



**APEX CODE 917**  
**Goose Neck Clamp**

917-1	11x100	M10	606/-	10
917-2	14x125	M12	636/-	10
917-3	18x160	M16	1104/-	10
917-4	22x200	M20	2016/-	4
917-5	26x250	M24	3774/-	4



**APEX CODE 920**  
**Hex Nut**

920-1	M8	19/-	50
920-2	M10	22/-	50
920-3	M12	30/-	50
920-4	M16	48/-	50
920-5	M20	84/-	30
920-6	M24	132/-	20
920-7	M30	249/-	10



**APEX CODE 921**  
**Flanged Nut (As Per IS : 7795-1975)**

921-1	M8	30/-	50
921-2	M10	42/-	50
921-3	M12	54/-	50
921-3A	M14	72/-	50
921-4	M16	87/-	50
921-5	M20	135/-	30
921-6	M24	162/-	30
921-7	M30	349/-	30

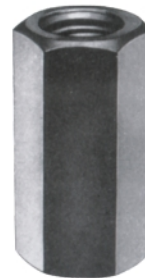

To Suit T-Slot	Price Each Rs.	Std. Pkg.
-------------------	-------------------	--------------

**APEX CODE 922**  
**Coupling Nut**

922-1	M10	33/-	50
922-2	M12	45/-	50
922-3	M16	90/-	50
922-4	M20	159/-	50
922-5	M24	267/-	30
922-6	M30	519/-	10

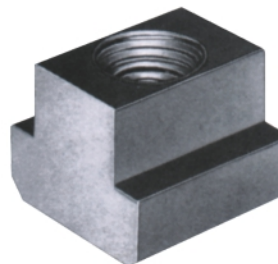

**APEX CODE 923**  
**T-Slot Nut (As Per IS 2015-1977)**  
(In accordance with DIN 508 Standard)

923-0	8xM6	30/-	50
923-1	10xM8	42/-	50
923-2	12xM10	48/-	50
923-2A	14xM10	60/-	50
923-3	14xM12	60/-	50
923-3A	16xM12	87/-	50
923-3B	18xM12	99/-	50
923-5	18xM16	96/-	50
923-5A	20xM16	114/-	50
923-5B	22xM16	165/-	30
923-7	22xM20	165/-	20
923-7A	28xM20	288/-	10
923-9	28xM24	288/-	10



**APEX CODE 925**  
**Plain Washer**  
(In accordance with DIN 6340 Standard)

925-1	M8	24/-	50
925-2	M10	27/-	50
925-3	M12	45/-	50
925-4	M16	63/-	50
925-5	M20	78/-	50
925-6	M24	114/-	30
925-7	M30	213/-	20



**APEX CODE 926**  
**Spherical Washer with Conical Seat**  
(In accordance with DIN 6319 Type C  
DIN 6319 Type D Standard)

926-1	M8	36/-	50
926-2	M10	42/-	50
926-3	M12	57/-	50
926-4	M16	81/-	50
926-5	M20	126/-	30
926-6	M24	186/-	30
926-7	M30	324/-	10



**APEX CODE 928**  
**C-Washer (As Per IS : 4291-1996)**  
(In accordance with DIN 6372)

928-1	M8	54/-	50
928-2	M10	66/-	50
928-3	M12	90/-	50
928-4	M16	150/-	50
928-5	M20	219/-	30
928-6	M24	312/-	30
928-7	M30	474/-	10

Size in mm	Price Each Rs.	Std. Pkg.
---------------	-------------------	--------------

**APEX CODE 929**  
T-Bolts (As Per IS 2014:1977)

929-5	10MMxM10	40	59/-	30
929-5A		50	60/-	30
929-6		65	63/-	30
929-7		80	66/-	30
929-8		100	81/-	20
929-9	12MMxM12	50	75/-	50
929-10		65	81/-	50
929-11		80	84/-	50
929-12		100	96/-	50
929-13		125	105/-	50
929-14		160	120/-	50
929-15		200	135/-	30
929-15A		250	165/-	20
929-16	14MMxM12	50	81/-	50
929-17		65	96/-	50
929-18		80	102/-	50
929-19		100	111/-	50
929-20		125	117/-	50
929-21		160	129/-	50
929-22		200	153/-	30
929-23		250	183/-	10
929-23A		320	237/-	10
929-24	16MMxM16	65	114/-	50
929-25		80	123/-	50
929-26		100	135/-	50
929-27		125	153/-	50
929-28		160	162/-	30
929-29		200	213/-	30
929-30		250	279/-	10
929-30A		320	297/-	30
929-31	18MMxM16	65	123/-	50
929-32		80	141/-	50
929-33		100	150/-	50
929-34		125	156/-	50
929-35		160	168/-	20
929-36		200	213/-	20
929-37		250	279/-	10
929-37A		320	336/-	20
929-38	20MMxM20	80	165/-	20
929-39		100	180/-	20
929-40		125	225/-	20
929-41		160	246/-	10
929-42		200	258/-	10
929-43		250	336/-	10
929-43A		320	420/-	10
929-44	22MMxM20	80	216/-	20
929-45		100	231/-	20
929-46		125	249/-	20
929-47		160	297/-	10
929-48		200	312/-	6
929-49		250	369/-	6
929-50		320	477/-	6
929-51	24MMxM24	100	339/-	6
929-52		125	366/-	6
929-53		160	378/-	6
929-54		200	426/-	6
929-55		250	540/-	6
929-56		320	546/-	6
929-57		400	651/-	6
929-58	24MMxM28	100	384/-	6
929-59		125	429/-	6
929-60		160	525/-	6
929-61		200	648/-	6
929-62		250	855/-	6
929-63		320	888/-	6
929-64		400	1044/-	6



To Suit T-Slot	Price Each Rs.	Std. Pkg.
-------------------	-------------------	--------------

**APEX CODE 930**  
Clamping Studs  
(As Per IS 13178:1991)

930-0	M8	32	21/-	20
930-1		40	24/-	20
930-2		50	27/-	20
930-3		63	30/-	20
930-4		80	33/-	20
930-5		100	36/-	20
930-6	M10	50	27/-	20
930-7		63	30/-	20
930-8		80	33/-	30
930-9		100	36/-	30
930-10		125	48/-	20
930-10A		160	60/-	20
930-10B		200	75/-	10
930-11	M12	50	30/-	50
930-12		63	33/-	30
930-13		80	36/-	30
930-14		100	45/-	30
930-15		125	60/-	30
930-16		160	75/-	30
930-17		200	96/-	30
930-17A		250	105/-	20
930-17B		315	168/-	10
930-18	M16	63	45/-	30
930-19		80	54/-	30
930-20		100	81/-	30
930-21		125	93/-	30
930-22		160	114/-	30
930-23		200	153/-	30
930-24		250	189/-	20
930-24A		315	231/-	10
930-25	M20	80	84/-	10
930-26		100	138/-	10
930-27		125	183/-	10
930-28		160	198/-	10
930-29		200	219/-	10
930-30		250	279/-	10
930-31		315	339/-	10
930-32		400	405/-	10
930-32A		450	441/-	10
930-33		500	525/-	10
930-34	M24	100	135/-	10
930-35		125	183/-	10
930-36		160	213/-	10
930-37		200	276/-	10
930-38		250	333/-	10
930-39		315	450/-	10
930-40		400	543/-	10
930-40A		450	630/-	10
930-41		500	684/-	10



**APEX CODE 930S**  
Clamping Stud with Slot  
Having Tapped Holes.  
(Hardened & Tempered)

930S-1	M12	100	75/-	20
930S-2		125	90/-	20
930S-3		150	96/-	20
930S-4		175	105/-	20
930S-5	M16	125	120/-	20
930S-6		150	135/-	20
930S-7		175	162/-	20
930S-8		200	171/-	20
930S-8A	M20	125	162/-	10
930S-9		150	183/-	10
930S-10		175	213/-	10
930S-11		200	231/-	10
930S-11A	M24	150	234/-	10
930S-12		175	279/-	10
930S-13		200	312/-	10
930S-14		225	333/-	10







Size in mm	Price Each Rs.	Std. Pkg.
------------	----------------	-----------

**APEX CODE 931**  
Clamping Kit - 34 Pcs.  
(With Adjustable Plates & Strap Clamps) in Elegant Metallic Steel Box

931-1	14-12 M	5892/-	2
931-2	16-12 M	5955/-	2
931-3	18-12 M	6021/-	2
931-4	18-16 M	7356/-	2



**APEX CODE 932**  
Clamping Kit - 58 Pcs.  
(With Step Blocks & Stepped Strap Clamps) in Elegant Metallic Steel Rack

932-1	14-12 M	9876/-	2
932-2	16-12 M	9969/-	2
932-3	18-12 M	10086/-	2
932-4	18-16 M	13578/-	2



**APEX CODE 933**  
Universal Strap Clamp  
(with T-Bolt & Special Nut)

933-1	1212x100	792/-	10
933-2	1412x100	801/-	10
933-3	1616x100	1053/-	10
933-4	1816x100	1059/-	10
933-5	2020x160	1554/-	4
933-6	2220x160	1572/-	4
933-7	2424x250	2271/-	4
933-8	2824x250	2292/-	4



**APEX CODE 934**  
Mould Clamp  
(with Stud & Flange Nut)

934-1	12x100	789/-	10
934-2	16x125	1065/-	10
934-3	20x175	1575/-	4
934-4	24x200	2199/-	4
with T-bolt & Flanged Nut			
934-5	1212x100	831/-	10
934-6	1412x100	837/-	10
934-7	1616x160	1116/-	10
934-8	1816x160	1116/-	10
934-9	2020x160	1677/-	4
934-10	2220x160	1695/-	4
934-11	2424x250	2622/-	4
934-12	2824x250	2622/-	4



**APEX CODE 935**  
Open End Mould Clamp  
(Clamp Price only)

935-1	M-12	624/-	10
935-2	M-16	927/-	10
935-3	M-20	1758/-	4
935-4	M-24	2187/-	4

**APEX CODE 935 B**  
Bolt only for above

935B-1	M-12	96/-	10
935B-2	M-16	138/-	10
935B-3	M-20	231/-	10
935B-4	M-24	303/-	10



**APEX CODE 936**  
Slotted Clamp (As Per IS:6082-1985)  
D x L Suitable for Screw Sizes

936-1	11x75	M10	294/-	10
936-2	11x95	M10	315/-	10
936-3	14x100	M12	417/-	10
936-4	14x115	M12	462/-	10
936-5	18x120	M16	528/-	10
936-6	18x135	M16	561/-	10
936-7	22x140	M20	927/-	4
936-8	22x150	M20	966/-	4
936-9	26x200	M24	1554/-	4
936-10	26x240	M24	1812/-	4



To Suit T-Slot	Price Each Rs.	Std. Pkg.
----------------	----------------	-----------

**APEX CODE 937**  
Double Ended Clamp  
(As per IS:6080-1985)

937-1	11x60	M10	189/-	10
937-2	11x85	M10	231/-	10
937-3	14x100	M12	321/-	10
937-4	14x125	M12	384/-	10
937-5	18x125	M16	426/-	10
937-6	18x150	M16	492/-	10
937-7	22x150	M20	789/-	4
937-8	22x200	M20	987/-	4

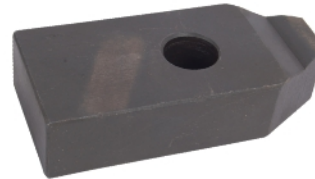

**APEX CODE 938**  
Plain Clamp  
(As Per IS:6081-1971)

938-1	11x70	M10	252/-
938-2	14x80	M12	270/-
938-3	18x100	M16	390/-
938-4	22x120	M20	654/-
938-5	26x150	M24	999/-



**APEX CODE 939**  
Table Clamp  
(As Per IS:5251-1984)

939-1	11x23	M10	198/-
939-2	11x30	M10	228/-
939-3	14x26	M12	270/-
939-4	14x33	M12	327/-
939-5	18x35	M16	450/-
939-6	18x40	M16	459/-
939-7	22x40	M20	588/-
939-8	22x45	M20	726/-



**APEX CODE 501**  
Bearing Puller 3 Legs Universal  
Drop Forged Steel

75	318/-	10
100	423/-	10
150	624/-	10
200	840/-	10
250	1224/-	6
300	1464/-	6



**APEX CODE 501A**  
Bearing Puller 2 Legs Universal  
Drop Forged Steel

75	312/-	10
100	411/-	10
150	606/-	10
200	819/-	10
250	1203/-	6
300	1446/-	6



Size in mm	Price Each Rs.	Std. Pkg.
------------	----------------	-----------

**APEX CODE 501 PC**  
Bearing Puller D/F 3 Legs (Double Hole Powder Coated)

75	339/-	20
100	453/-	20
150	675/-	20
200	900/-	10



**APEX CODE 501 H**  
Bearing Puller Hand Forged Steel 3 Legs

14"	1770/-	6
16"	2028/-	6
18"	2277/-	6
20"	2808/-	6
22"	3084/-	4
24"	3363/-	4



**APEX CODE 501 AH**  
Bearing Puller Hand Forged Steel 2 Legs

14"	1734/-	6
16"	1980/-	6
18"	2223/-	6
20"	2742/-	6
22"	3018/-	4
24"	3291/-	4



**APEX CODE 502**  
G Clamps Malleable

50	144/-	60
75	204/-	40
100	267/-	40
125	333/-	20
150	414/-	20
200	558/-	20
250	996/-	10
300	1197/-	10



**APEX CODE 503**  
Drop Forged G. Clamps

50	279/-	50
75	423/-	40
100	582/-	40
150	894/-	40
200	1347/-	10
250	2439/-	6
300	3012/-	4



**APEX CODE 504**  
Adj. Tap Wrench (Auto Black Drop Forged Carbon Steel Hardened & Tempered)

6.5	246/-	50
10	291/-	50
13	318/-	50
20	441/-	20
25	654/-	10
31	720/-	10
40	1305/-	10
50	2259/-	10

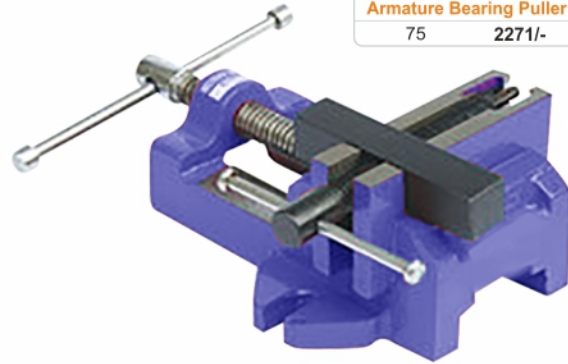

**APEX CODE 505**  
Armature Bearing Puller Vice

75	2271/-	4
----	--------	---

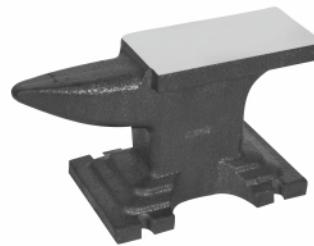

**APEX CODE 506**  
Anvil

1 kgs	297/-
2 kgs	600/-
5 kgs	1380/-
10 kgs	2766/-
15 kgs	4143/-
20 kgs	5526/-
25 kgs	6912/-
30 kgs	8295/-
40 kgs	10290/-
50 kgs	12759/-
60 kgs	15309/-
70 kgs	17862/-
75 kgs	19134/-
100 kgs	25515/-



**APEX CODE 507**  
Drill Sleeves  
(Workshop Grade)

M.T. No.	Price	Qty
0-1	96/-	100
2-1	105/-	100
3-2	141/-	50
4-3	258/-	50
5-4	630/-	30
6-5	1824/-	30
3-1	162/-	100
4-1	294/-	100
4-2	294/-	100
5-1	705/-	50
5-2	705/-	50
5-3	705/-	50
6-2	2085/-	30
6-3	2085/-	30
6-4	2085/-	30



**APEX CODE 508**  
Drill Chuck with Key

1/2"	753/-	30
------	-------	----





**APEX**<sup>®</sup>

SINCE 1959

An ISO 9001-2015 Company

---

#### Terms & Conditions

- All prices are exclusive GST. GST will be charged extra.
  - Prices are F.O.R. Jalandhar.
  - Order will be accepted for supply in standard carton packaging as mentioned in list.
  - Subject to Jalandhar Jurisdiction only.
- 

Authorised Dealer

**APEX INDUSTRIES**  
**JALANDHAR 144 004 (INDIA)**

visit us at : [www.apexmachinevices.com](http://www.apexmachinevices.com)

Follow us  @apexvices